

Pavo 6" Arrays

SIP12436 6.00 in

SPILIGHTING

PROJECT DETAILS

JOB NAME:

TYPE:

NOTES:

DESCRIPTION

Minimalist form meets functional lighting with the Pavo pendant. Characterized by its meticulous attention to detail, Pavo features even illumination (top to bottom and radially) and clean-finished ends that satisfy the highest-end applications. And true to its minimalist design, it has no metal collars to break the form. Hang individual pendants or mix different sizes to create visual arrays. Available in lengths from 1 to 8 feet long.

3 FIXTURE ARRAY

FEATURES & BENEFITS

- Matching bi-planar finish detail on top and bottom maximizes visual appeal from all angles
- Integrated LED luminaire design features a sophisticated passive cooling system with integrated heat sink
- 1100lm integral regressed downlight available with beam spread of spot (19°), narrow (35°), and medium (45°)
- Ambient and downlight components are standard with separate switching and 0-10v dimming
- Add a splash of color with optional top and bottom decorative accents
- Available in either stem or power cord suspension with driver located in canopy; remote driver option available.
- Handcrafted in USA

SPECIFICATIONS

- **LIGHT SOURCE:** White LED light engine (contact factory for RGBW or Tunable White)
- **CRI:** 80+ or 90+
- **LUMEN MAINTENANCE:** L80 = >60,000 Hrs.
- **EFFICACY:** up to 110 lm/W delivered
- **CCT:** 2700K, 3000K, 3500K, 4000K, 5000K
- **VOLTAGE:** 120-277V standard
- **DRIVER:** Class 2 power supply integrated in canopy standard; remote optional. Max distance to the driver (including OAH) is: #18 AWG = 50', #16 AWG = 75', #14 AWG = 100'. For extended

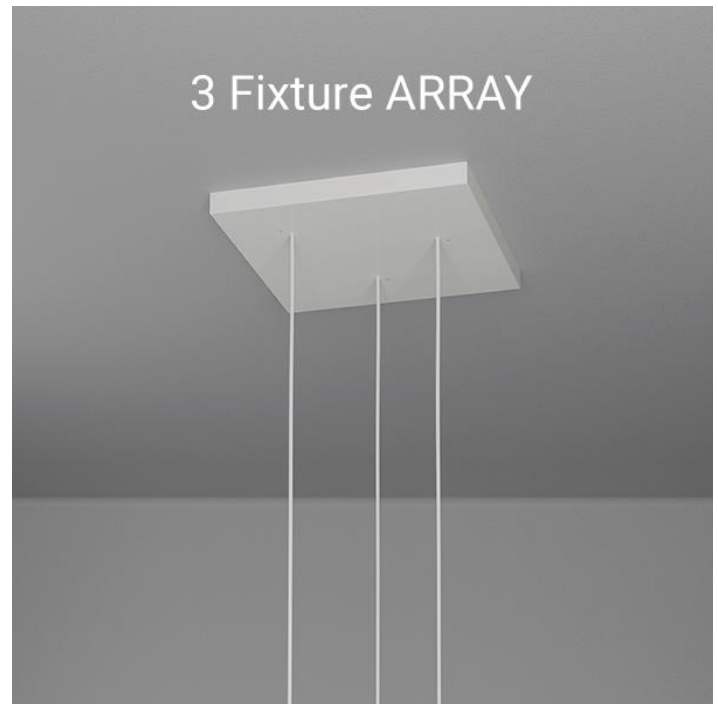

distances, contact factory.

- **DIMMING:** 1% minimum dim level standard
- **CONTROLS:** 0-10V standard. Lutron Athena, Current NX, and nLight AIR optional. Contact factory for other controls (e.g., Enlighted, Encelium, Wattstopper, WaveLinx, or Casambi)
- **EMERGENCY:** Remote battery option is provided with 10W Constant Power Battery back-up, providing 90 Minutes of Emergency operation. Contact factory for other Emergency options.
- **INTEGRATED SURGE PROTECTION:** LED components are protected against minor surge events
- **DIFFUSER:** White matte acrylic diffuser standard; white gloss acrylic diffuser optional
- **CONSTRUCTION:** Aluminum
- **FINISH:** End plates and mounting components finished to match. To specify separately, contact factory. Choose from 26 standard thermoset polyester powder coat paint colors. Brushed aluminum available on decorative accents only. RAL®, Pantone®, or custom finishes available upon request.
- **MODIFICATIONS:** Consult factory for all modification requests, including RGBW, Tunable White, or other sizes
- **APPROVALS:** ETL listed to UL standards (US & Canada) for use in damp locations; not recommended for exterior applications

DIMENSIONS

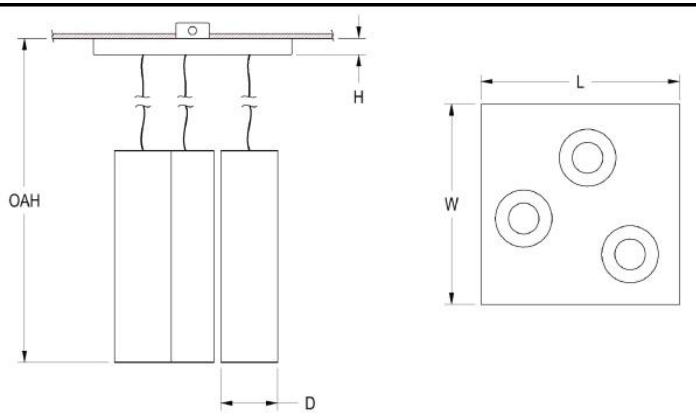

1FT	W	L	H	D	OAH
	21 in 53.3 cm	21 in 53.3 cm	1.8 in 4.4 cm	6 in 15.2 cm	66 in 167.6 cm

Mounting Weight: Approximate: 30 lb (14 kg)

2FT	W	L	H	D	OAH
	21 in 53.3 cm	21 in 53.3 cm	1.8 in 4.4 cm	6 in 15.2 cm	74 in 188 cm

Mounting Weight: Approximate: 30 lb (14 kg)

3FT	W	L	H	D	OAH
	21 in 53.3 cm	21 in 53.3 cm	1.8 in 4.4 cm	6 in 15.2 cm	85 in 215.9 cm

Mounting Weight: Approximate: 45 lb (21 kg)

4FT	W	L	H	D	OAH
	21 in 53.3 cm	21 in 53.3 cm	1.8 in 4.4 cm	6 in 15.2 cm	97 in 246.4 cm

Mounting Weight: Approximate: 45 lb (21 kg)

6FT	W	L	H	D	OAH
	21 in 53.3 cm	21 in 53.3 cm	1.8 in 4.4 cm	6 in 15.2 cm	121 in 307.3 cm

Mounting Weight: Approximate: 60 lb (28 kg)

8FT	W	L	H	D	OAH
	21 in 53.3 cm	21 in 53.3 cm	1.8 in 4.4 cm	6 in 15.2 cm	145 in 368.3 cm

Mounting Weight: Approximate: 75 lb (35 kg)

CONFIGURATOR

To configure your spec sheet online, go to www.spilighting.com/SIP12436. Not all options are available in all configurations; consult factory for details.

Required Field *

Catalog	Light Source*	Primary Finish*	Voltage*	Lamp Options*	CRI*	Controls*	Light Source Option*	Diffuser	Mounting*	Emergency	Accents	Other Than Standard Options
SIP12436												
	A	B	C	D	E	F	G	H	I	J	K	
Paint Colors												
L												

A - LIGHT SOURCE *

To ensure color consistency, SPI uses precise bin selection and strict quality processes to maintain a 3-step (MacAdam) SDCM on all white LED lampings. Published LED luminaire wattages are calculated using a typical power supply efficiency of 88%; exact wattages may vary based on application. Alternative wattages available upon request.

1 FOOT NOMINAL FIXTURE

(3) 1FT - L8W | White 8W LED Light Engine | Delivered Lumens: 2,655

2 FOOT NOMINAL FIXTURE

(3) 2FT - L11W | White 11W LED Light Engine | Delivered Lumens: 3,651

(3) 2FT - L23W | White 23W LED Light Engine | Delivered Lumens: 7,632

3 FOOT NOMINAL FIXTURE

- (3) 3FT - L19W | White 19W LED Light Engine | Delivered Lumens: 6,303
- (3) 3FT - L38W | White 38W LED Light Engine | Delivered Lumens: 12,609

4 FOOT NOMINAL FIXTURE

- (3) 4FT - L26W | White 26W LED Light Engine | Delivered Lumens: 8,628
- (3) 4FT - L53W | White 53W LED Light Engine | Delivered Lumens: 17,586

6 FOOT NOMINAL FIXTURE

- (3) 6FT - L42W | White 42W LED Light Engine | Delivered Lumens: 13,935
- (3) 6FT - L83W | White 83W LED Light Engine | Delivered Lumens: 27,540

8 FOOT NOMINAL FIXTURE

- (3) 8FT - L57W | White 57W LED Light Engine | Delivered Lumens: 18,912

See last page for finish options

B - VOLTAGE *

- DF_120-277V | Universal Voltage

C - LAMP OPTIONS *

Apply multiplier from charts for delivered lumens at other CCT's and CRI's.

- 3500K | 3500K CCT
- 4000K | 4000K CCT
- 5000K | 5000K CCT
- 2700K | 2700K CCT
- 3000K | 3000K CCT

	MAIN BODY LIGHT		DOWN LIGHT		
	80 CRI	90 CRI	80 CRI	90 CRI	
2700K	0.91	0.77	2700K	0.92	0.80
3000K	0.94	0.80	3000K	0.95	0.82
3500K	0.97	0.82	3500K	0.97	0.86
4000K	1.00	0.85	4000K	1.00	0.86
5000K	1.00	0.85	5000K	1.00	n/a
2700K			3000K		

D - CRI *

- DF_80 | (default)
- 90

E - CONTROLS *

All controls allow for independent dimming of ambient and downlight components. Extended lead times may apply for controls other than 0-10V. Contact factory for additional control options such as Enlighted, Encelium, Wattstopper, WaveLinx, Casambi, or others.

- DF_DIM1 | 0-10V Control, 1% Dimming (default)
- NX | Current NX Wireless, 1% Dimming
- AWRN | Lutron Athena Wireless Node, 1% Dimming
- NLTA | Acuity nLight Air, 1% Dimming

F - LIGHT SOURCE OPTION *

- DF_No DL | No Downlight
- (3) 14W-19° Spot | 42W (3300 delivered lumens) Downlight - 19° Beam
- (3) 14W-35° Narrow | 42W (3300 delivered lumens) Downlight - 35° Beam
- (3) 14W-45° Medium | 42W (Total Delivered Lumens: 3,300) Downlight - 45° Beam

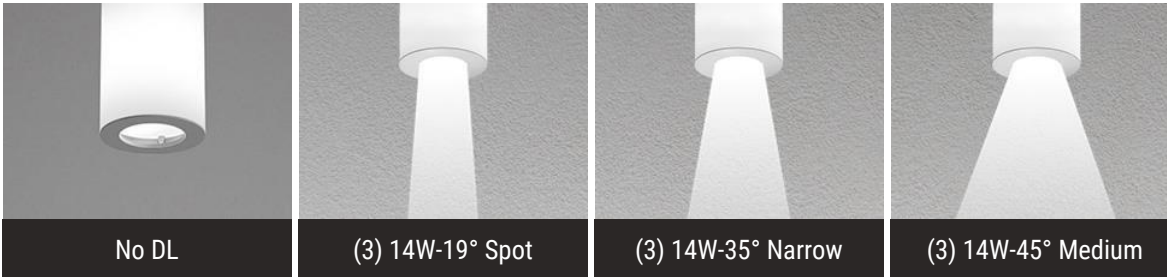

G - DIFFUSER

- DF_MA01 | Matte Acrylic Diffuser Lens (default)
- HP03- 1' | Amber Hand Painted Acrylic Diffuser
- HP03- 2' | Amber Hand Painted Acrylic Diffuser
- HP03- 3' | Amber Hand Painted Acrylic Diffuser
- HP03- 4' | Amber Hand Painted Acrylic Diffuser
- HP03- 6' | Amber Hand Painted Acrylic Diffuser
- HP03- 8' | Amber Hand Painted Acrylic Diffuser
- HP02- 1' | Beige Hand Painted Acrylic Diffuser
- HP02- 2' | Beige Hand Painted Acrylic Diffuser
- HP02- 3' | Beige Hand Painted Acrylic Diffuser
- HP02- 4' | Beige Hand Painted Acrylic Diffuser
- HP02- 6' | Beige Hand Painted Acrylic Diffuser
- HP02- 8' | Beige Hand Painted Acrylic Diffuser
- HP01- 1' | Silver Hand Painted Acrylic Diffuser
- HP01- 2' | Silver Hand Painted Acrylic Diffuser
- HP01- 3' | Silver Hand Painted Acrylic Diffuser
- HP01- 4' | Silver Hand Painted Acrylic Diffuser
- HP01- 6' | Silver Hand Painted Acrylic Diffuser
- HP01- 8' | Silver Hand Painted Acrylic Diffuser
- OA | White Gloss Acrylic Diffuser



MA01

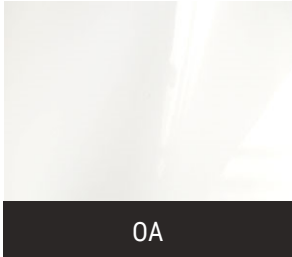

OA

H - MOUNTING *

Mounts to a standard 4" octagonal junction box. The PSC and CAC mountings utilize a white power cord. The CAS mounting has a 22.5° swivel and the PSS mounting swivels 45°.

- DF_PSC | Power Supply Canopy with Cord Suspension (default)
- CAC | Power Cord Suspension with Remote Power Supply & Canopy
- CAS | Canopy & Stem, Remote Supply
- PSS | Power Supply Canopy & Stem

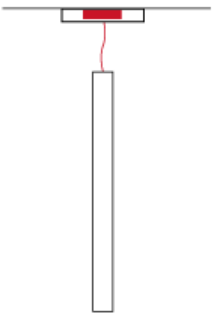

DF_PSC

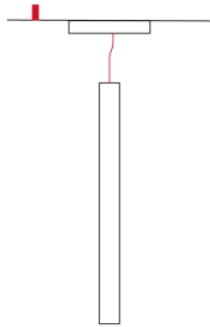

CAC

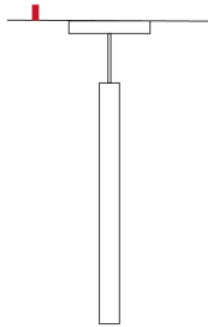

CAS

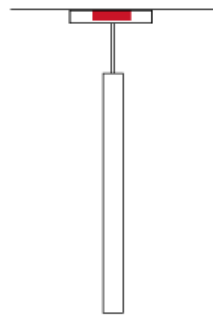

PSS

I - EMERGENCY

- EMR | Emergency Battery Remote

J - ACCENTS

- AC1 | Decorative Accent Top
- AC2 | Decorative Accent Top and Bottom

K - OTHER THAN STANDARD OPTIONS

Specify overall height required from ceiling to the bottom of the fixture. For varying stem length on an Array, please contact factory.

OAH | Pendant suspension length other than standard

Standard Finishes

The colors shown are representative. Their actual appearance may vary due to differences in display settings. You can request color chips by emailing contact@spilighting.com. Please note, finishes may not be available in all configurations.

Paint Colors

PT01 RAL9003 Signal White (Gloss)	PT51 Matte White (Textured)	PT02 White (Textured)	PT04 RAL9001 Cream (Textured)	PT67 RAL7044 Silk Grey (Textured)
PT53 RAL7035 Light Grey (Textured)	PT54 RAL7037 Dusty Grey (Textured)	PT55 RAL7012 Basalt Grey (Textured)	PT56 RAL7016 Anthracite Grey (Textured)	PT11 Black (Textured)
PT57 RAL1015 Light Ivory (Textured)	PT58 RAL8004 Copper Brown (Textured)	PT59 RAL6021 Pale Green (Textured)	PT60 RAL1019 Grey Beige (Textured)	PT61 RAL7006 Beige Grey (Textured)
PT62 RAL1003 Signal Yellow (Textured)	PT63 RAL3001 Signal Red (Textured)	PT64 RAL6001 Emerald Green (Textured)	PT65 RAL5005 Signal Blue (Textured)	PT66 RAL5003 Sapphire Blue (Textured)

Metallic Paint Colors

PT22 Platinum (Metallic Gloss)	PT48 Brass (Metallic Textured)	PT28 Dark Stainless (Metallic Gloss)	PT49 Bronze (Metallic Textured)	PT32 Dark Bronze (Metallic Gloss)
PT46 Aluminum (Metallic Textured)				

Brushed Aluminum

BAL Brushed Aluminum	MAL Microbrushed Aluminum
--------------------------------	-------------------------------------

Specialty Finishes



More RAL®, Pantone®, and custom finishes are available upon request. Setup fee and additional lead time applies. Call factory for details.